

# UNO-348

## Expandable Embedded Box IPC with 10th Gen Intel® CPU



### Features

- 10th gen Intel® socket-type processor with DDR4 memory
- Scalable processor and RAM memory options
- Compact, rugged, fanless design for harsh embedded environments
- Flexible expansion with up to 3 x PCIe/PCI slots, 1 x M.2 (B-key), 1 x mPCIe, and 2 x 2.5" SSD
- Optional iDoor expansion
- Remote out-of-band (OOB) power management with Advantech's iBMC technology
- Built-in TPM2.0 for hardware-based security

### Introduction

UNO-348 is a high-performance, fanless, embedded edge controller equipped with a 10th gen. Intel® Core™ i5 processor with 8/16 GB DDR4 memory and Intel® Intel H420E and W480E PCH chipset. Despite its compact size, UNO-348 offers multiple I/O including 4 x USB 3.2, 2 x USB 2.0, 3 x GigaLAN, 2 x RS-232/422/485, and 1 x RS-232 ports, as well as 1 x Line-out, 1 x Mic-in, 1 x DisplayPort, and 1 x HDMI interfaces. Designed to deliver high-performance computing and maximum flexibility for industrial automation applications, UNO-348 also features 2 x internal HDD/SSD bays, 1 x full-size mPCIe, 1 x M.2 B-key, and up to 3 x PCIe/PCI expansion slots (1 x PCIe x16, 2 x PCI) to support the integration of optional peripherals. UNO-348 is also equipped with Advantech's iBMC technology to support remote OOB power management to reduce system downtime and operational costs.

### Specifications

#### General

- **Certification** CB/UL, CE/FCC Class A, CCC, BSMI
- **Dimensions (W x D x H)** UNO-348-AXX1A: 120 x 200 x 140 mm/4.7 x 7.8 x 5.5 in  
UNO-348-AXX3A: 160 x 200 x 140 mm/6.3 x 7.8 x 5.5 in
- **Form Factor** Regular
- **Mounting** Wall, stand
- **Weight (Net)** UNO-348-AXX1A: 3.5 kg/7.7 lb  
UNO-348-AXX3A: 4 kg/8.8 lb
- **Power Requirements** 10 ~ 36 V<sub>DC</sub>  
Note: Power should be fixed at 24V<sub>DC</sub> (± 20%) when total power consumption exceeds 160W.
- **Power Consumption** 59W (typical), 100W (Max)  
When equipped with PCI/PCIe card:  
UNO-348-AXX1A: up to 174.1W  
UNO-348-AXX3A: up to 224.1W  
Note:  
PCIex16 slot supports up to 75W  
PCIex4 slot supports up to 25W  
PCIex1 slot supports up to 10W  
PCI slot supports up to 25W
- **OS Support** Windows 10 2019 LTSC, Windows 11, AdvLinux (Ubuntu 18.04)

#### Hardware

- **BIOS** AMI UEFI (128 Mbit)
- **Hardware Security** TPM2.0
- **Watchdog Timer** Programmable timer with 255 intervals (1 ~ 255 sec)
- **Processor\*** Intel® Core™ i5-10500TE, 2.3 GHz, 6 cores
- **Chipset** Intel® H420E (W480E available upon request)
- **Memory\*** i5 CPU: Built-in 8 GB DDR4, 2933 MHz, dual sockets support up to 64 GB  
Graphics Engine Intel HD Graphics
- **Ethernet** LAN A: Intel® i210-AT GbE, IEEE 802.3AZ/802.1AS  
LAN B: Intel® i210-AT GbE, IEEE 802.3AZ/802.1AS (Support iBMC)  
(W480) LAN C: Intel® i219-LM GbE, IEEE 802.3AZ/802.1AS (H420) LAN C: Intel® i219-V GbE, IEEE 802.3AZ/802.1AS

- **LED Indicators** 1 x Programmable LED, 1 x power LED, 1 x HDD LED, and 1 x LAN (active, status)
- **Storage/Expansion** 2 x 2.5" SSD/HDD bay (RAID is only supported by W480 chipset version upon request)  
1 x M.2 B key (SATA/ USB 3.0 signal) for 2242/2280 SATA SSD or 3042/3052 LTE/5G module expansion  
1 x Full-size mPCIe (PCIe/ USB2.0 signal)  
UNO-348-AXX1A: 1 x PCIex16,  
UNO-348-AXX3A: 1 x PCIex16, 2 x PCI

#### I/O

- **Serial Ports** 2 x RS-232/422/485, 1 x RS-232. 50bps ~115.2 kbps (DB9)
- **LAN Ports** 3 x RJ45, 10/100/1000 Mbps IEEE 802.3u 1000BASE-T Fast Ethernet
- **USB Ports** 4 x USB 3.2 Gen 1, 2 x USB 2.0 (Type A)
- **Displays** 1 x DP 1.4, supports 4096 x 2304 @ 60Hz (DP++)  
1 x HDMI 1.4, supports 4096 x 2160 @ 30Hz
- **Audio** Mic-in, Line-out (Line-out can be configured as Line-in upon request)
- **Power Connector** 1 x 4-pin terminal block
- **Remote Power Control** 1 x 2-pin terminal block that supports remote Power On/Off function (can support remote reset function via jumper settings)
- **GPIO** 1 x GPIO (8 bit) internal pin header

#### Environmental

- **Operating Temperature** -20 ~ 50 °C/-4 ~ 122 °F with 0.7m/s airflow
- **Storage Temperature** -40 ~ 85 °C/-40 ~ 185 °F
- **Relative Humidity** 95% RH @ 40 °C/104 °F, non-condensing
- **Shock Protection** Operating, IEC 60068-2-27, 50G, half sine, 11ms
- **Vibration Protection** Operating, IEC 60068-2-64, 4 Grms, random, 5 ~ 500 Hz, 1hr/axis (SSD)
- **Ingress Protection** IP20

\*The processor and memory can be flexibly configured. See ordering information for more details.

# Installation Options

Stand mount

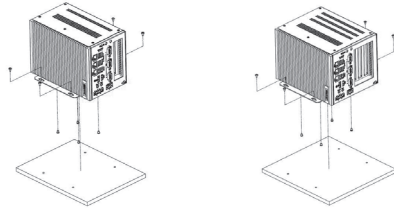

Wall mount

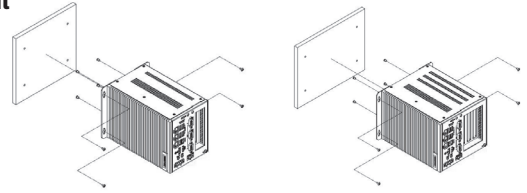

Note: Mount kit included with product as a default.

## Dimensions

Unit: mm

### UNO-348-AXX1A

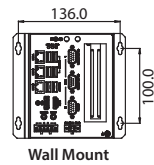
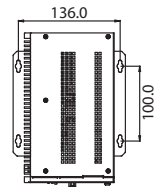
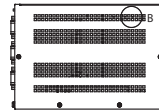
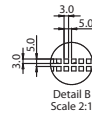
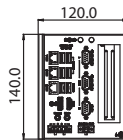
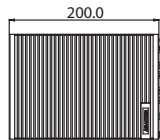
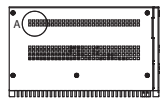
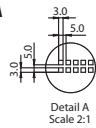

### UNO-348-AXX3A

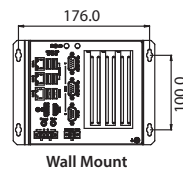
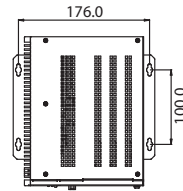
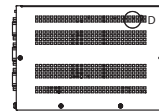
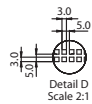
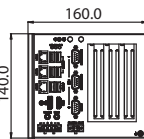
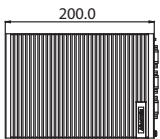
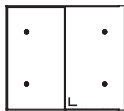
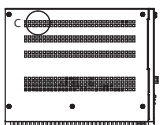
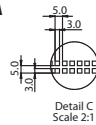

### UNO-348 Add on PCIE/PCI Card

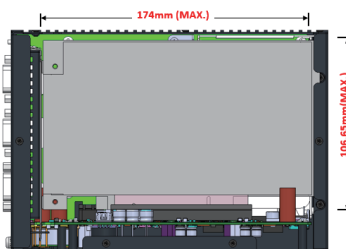

## I/O View

### UNO-348-AXX1A

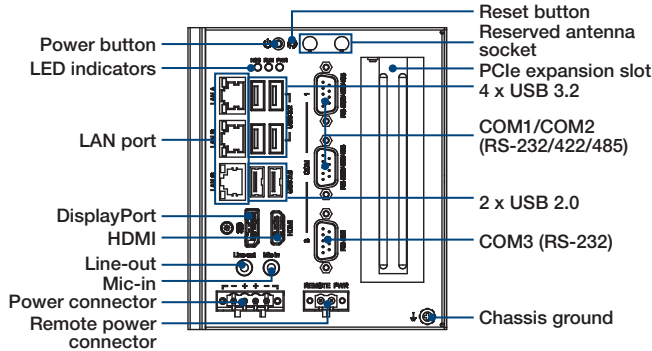

### UNO-348-AXX3A

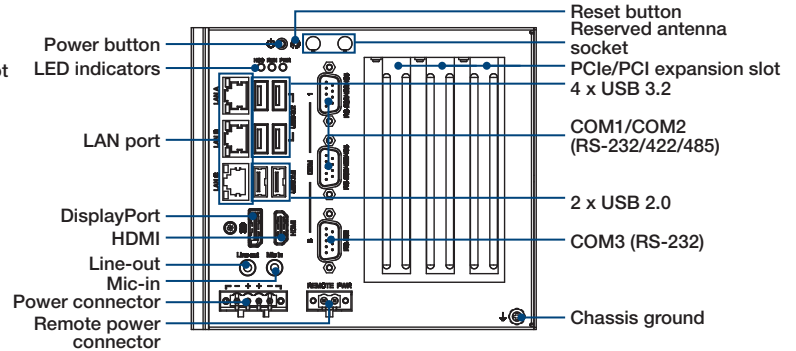

## Ordering Information

Part Number	Description	CPU	PCH	RAM	Number of PCIe/PCI Slots
*UNO-348-ANN3A	Intel® H420E chipset, 3 x COM, 6 x USB, 3 x LAN, 1 x PCIe x16, 2 x PCI	Optional. (Supports Intel® Core™ i7/i5/i3/Celeron®/Pentium®)	H420E	Optional support up to 64 GB	1 x PCIe x16, 2 x PCI
*UNO-348-ANN1A	Intel® H420E chipset, 3 x COM, 6 x USB, 3 x LAN, 1 x PCIe x16	Optional. (Supports Intel® Core™ i7/i5/i3/Celeron®/Pentium®)	H420E	Optional support up to 64 GB	1 x PCIe x16
UNO-348-A533A	Intel® Core™ i5-10500TE, 6-core CPU, Intel® H420E chipset, 8 GB RAM, 3 x COM, 6 x USB, 3 x LAN, 1 x PCIe x16, 2 x PCI	Intel® Core™ i5-10500TE	H420E	8 GB	1 x PCIe x16, 2 x PCI
UNO-348-A531A	Intel® Core™ i5-10500TE 6-core CPU, Intel® H420E chipset, 8 GB RAM, 3 x COM, 6 x USB, 3 x LAN, 1 x PCIe x16	Intel® Core™ i5-10500TE	H420E	8 GB	1 x PCIe x16
UNO-348-ANN3AW	Intel W480E Chipset, 3x COM, 6x USB, 3x LAN, 1x PCIe x16, 1x PCIe x4, 1x PCIe x1	Optional. (Supports Intel® Core™ i7/i5/i3/Celeron®/Pentium®)	W480E	Optional support up to 64GB	1x PCIe x16, 1x PCIe x4, 1x PCIe x1
UNO-348-ANN1AW	Intel W480E, 3x COM, 6x USB, 3x LAN, 1x PCIe x16	Optional. (Supports Intel® Core™ i7/i5/i3/Celeron®/Pentium®)	W480E	Optional support up to 64GB	1x PCIe x16

\*For this model, the processor and RAM memory must be ordered separately.

## Optional Expansion

### PCIe/PCI Backplane (for UNO-348-AXX3A)

- 9894U348A02 1x PCIe x16, 2x PCIe x1

### RAM

- SQR-SD4N8G3K2SNBCB SODIMM DDR4 3200 8GB
- SQR-SD4N16G3K2SNCB SODIMM DDR4 3200 16GB
- SQR-SD4N32G3K2SNAB SODIMM DDR4 3200 32GB

### iDoor Module

Please purchase an additional iDoor PCIe I/O plate for iDoor module installation.

- PCM-28P1BK-AE iDoor PCIe I/O plate

Note:

1. The iDoor I/O plate will occupy one of PCIe/PCI slot
2. Contact Advantech information about supported iDoor modules.

### GPIO cable

- 1700030635-01 D-SUB 9Pin GPIO cable 15cm

Note: Need to swap 1 x RS-232 to GPIO

## Optional Accessories

### Power Supply

- 96PSA-A230W24P4-3 ADP A/D 100 ~ 240V 230W 24V C14 4P terminal block

### Power Cable

- 1702002600 Power cable (USA) UL/CSA, 3-pin, 10A, 125V, 1.83M
- 1702002605 Power cable (EU), 3-pin, 10A, 250V, 1.83M
- 1700000596 Power cable CCC, 3-pin, 10A, 250V, 1.83M

### Wireless Solution

- AIW-355DQ-C01 5G(Sub-6G)/LTE/WCDMA module, GNSS, for China
- AIW-355DQ-E01 5G(Sub-6G)/LTE/WCDMA module, GNSS, for Europe
- AIW-355DQ-N01 5G(Sub-6G)/LTE/WCDMA module, GNSS, for US
- UNO-M2-3052HS M.2B 3052 Heatsink for AIW-355 5G module
- 1750008879-01 Cable Ant. SMA/F-BH MH4/113 BLK L150mm
- 1750009372-01 Dipole antenna, 5G(Sub-6G)/LTE/WCDMA full band, 167mm

## Embedded O/S

- 20704WX9HS0000 Win10 LTSC x64 v6.07 B008 for UNO-348 (High End)
- 20704WX9VS0000 Win10 LTSC x64 v6.07 B008 for UNO-348 (Value)
- 20704U20DS0004 AdvLinuxTU Embedded Linux x86\_64 v3.1.1

Caution: If the system is equipped with optional modules, additional certificates may be required in certain regions/countries. Contact Advantech for certification compliance.