

UNO-238

Compact IoT Edge Computer with
Intel® Core™ i Processor, 2 x GbE,
4 x USB 3.2, 2 x RS-232/422/485,
1 x HDMI, 1 x DP, 1 x GPIO

NEW



Features

- 8th generation Intel® Core™ i processor
- 2 x GbE, 4 x USB3.2, 2 x RS-232/422/485, 1 x HDMI, 1 x DP, 1 x GPIO (8 bit)
- Compact, fanless design
- Rubber stopper for stand mount and optional kit for DIN-rail mounting
- Can be expanded to facilitate wireless communication
- Threaded DC jack for reliable power supply
- Optimized mechanical design for easy RAM swapping



Specifications

General

- **Certification** CE, FCC, UL, CCC, BSMI
- **Dimensions (W x D x H)** 150 x 107 x 60 mm (5.91 x 4.22 x 2.36 in)
- **Form Factor** Small
- **Enclosure** Aluminum housing
- **Mount Options** Stand, DIN rail (optional)
- **Weight (Net)** 1.8 kg (3.9 lb)
- **Power Requirement** 12V_{DC}
- **Power Consumption** 31W (typical), 54W (Max)
- **OS Support** Windows 10 2019 LTSC, Windows 11, AdvLinux (Ubuntu 18.04)

System Hardware

- **BIOS** AMI EFI (256 Mbit)
- **Watchdog Timer** Programmable timer with 255 intervals (1 ~ 255 sec)
- **TPM** TPM2.0 (SLB9670XQ2.0)
- **Processor** Intel® i7-8665UE quad core, 1.7 GHz (up to 4.4 GHz)
Intel® i5-8365UE quad core, 1.6 GHz (up to 4.1 GHz)
Intel® i3-8145UE dual core, 2.2 GHz (up to 3.9 GHz)
- **Memory** 2 socket DDR4 2400 (up to 32 GB max.)
- **Graphics Engine** Intel® UHD Graphics 620
- **Ethernet** 10/100/1000 Mbps (LAN1: Intel® i219; LAN2: Intel® i210-IT)
- **LED Indicators** Power and HDD status
- **Storage** 32GB of eMMC 5.1 (Onboard)
1 x M.2 B Key 2280 (SATA or NVMe PCIe2), shared with expansion
- **Expansion** 1 x M.2 B Key 3042 (For LTE module, support USB 2.0 only), shared with storage
1 x M.2 E Key 2230 (For WiFi module, support PCIe and USB 2.0)
- **SIM slot** Yes (One for nano size)

I/O

- **Serial Ports** 2 x RS-232/422/485
- **LAN** 2 x RJ45, 10/100/1000 Mbps IEEE 802.3u
1000BASE-T Fast Ethernet
- **USB** 4 x USB 3.2
- **Displays** 1 x HDMI 1.4 (up to 4096 x 2160 @30/24 Hz)
1 x DP 1.2 (up to 4096 x 2306 @60 Hz)
- **Power Connector** 1 x Lockable DC jack
- **Audio** 1 x Line out (optional)
- **Others** 1 x GPIO (8 bit) (CAN bus 2.0 is available upon request)

Environment

- **Operating Temperature** -20 ~ 60 °C/-4 ~ 140 °F with 0.7m/s air flow and extended temperature peripherals (for more information refer to the optional memory list on page 2)
- **Storage Temperature** -40 ~ 85 °C/-40 ~ 185 °F
- **Relative Humidity** 10 ~ 95% RH @ 40 °C/104 °F, non-condensing
- **Shock Protection** Operating, IEC 60068-2-27, 50G, half sine, 11ms
- **Vibration Protection** Operating, IEC 60068-2-64, 3Grms, random, 5 ~ 500Hz, 1hr/axis

Installation Scenario

Wall/Stand Mount

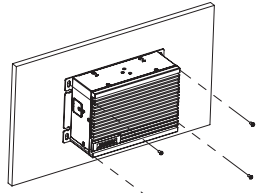

Wall Mount

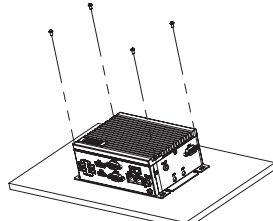

Stand Mount

DIN-Rail Mount (with optional DIN-rail kit)

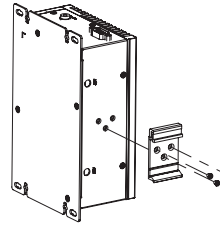

Dinrail Assemble Explode

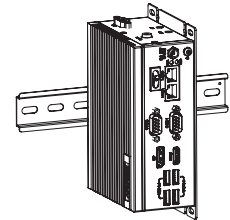

Dinrail Install

Dimensions

Unit: mm

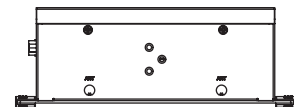
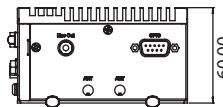
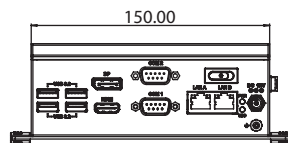
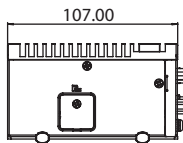
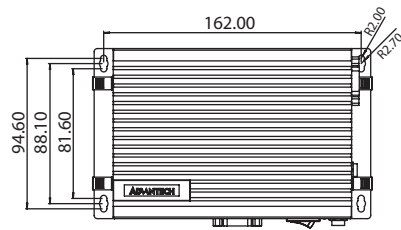

Front I/O

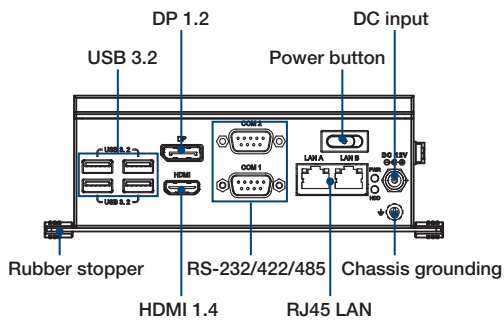

Right I/O

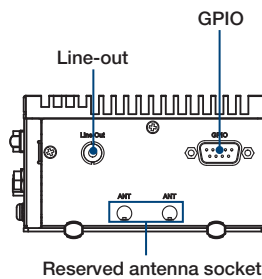

Rear I/O

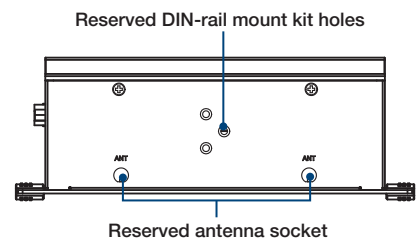

Ordering Information

	Part Number	CPU	Max. Frequency	Core	Storage	COM	USB	Display	GPIO	TPM
With Audio Version	UNO-238-83N1AE	i3-8145UE	3.90 GHz	2	32G eMMC	2 x RS-232/422/485	4 x USB 3.2	1 x DP/HDMI	Y	Y
	UNO-238-85N1AE	i5-8365UE	4.10 GHz	4	32G eMMC	2 x RS-232/422/485	4 x USB 3.2	1 x DP/HDMI	Y	Y
	UNO-238-87N1AE	i7-8665UE	4.40 GHz	4	32G eMMC	2 x RS-232/422/485	4 x USB 3.2	1 x DP/HDMI	Y	Y
	UNO-238-87N1AU (Made in Taiwan)	i7-8665UE	4.40 GHz	4	32G eMMC	2 x RS-232/422/485	4 x USB 3.2	1 x DP/HDMI	Y	Y
Without Audio Version	UNO-238-83N1AO	i3-8145UE	3.90 GHz	2	32G eMMC	2 x RS-232/422/485	4 x USB 3.2	1 x DP/HDMI	Y	Y
	UNO-238-85N1AO	i5-8365UE	4.10 GHz	4	32G eMMC	2 x RS-232/422/485	4 x USB 3.2	1 x DP/HDMI	Y	Y
	UNO-238-87N1AO	i7-8665UE	4.40 GHz	4	32G eMMC	2 x RS-232/422/485	4 x USB 3.2	1 x DP/HDMI	Y	Y

Suggested Memory List

Capacity	Temp.	P/N
4G	0 ~ 85 °C	AQD-SD4U4GN24-SG
		AQD-SD4U4GN26-SG
	-40-85 °C	SQR-SD4N4G2K6SNEFB
		SQR-SD4I4G2K6SNEFB
8G	0 ~ 85 °C	AQD-SD4U8GN24-SE
		AQD-SD4U8GN26-SE
	-40-85 °C	SQR-SD4N8G2K6SNBCB
		SQR-SD4I8G2K6SNBCB
16G	0 ~ 85 °C	AQD-SD4U16N24-SE
		AQD-SD4U16N26-SE
	-40-85 °C	SQR-SD4N16G2K6SNCB
		SQR-SD4I16G2K6SNCB

Packing list

Items	P/N
60W 12V Adapter	96PSA-A60W12W7-3
Thermal grease (for CPU)	2170000093-01
Thermal pad (for 2nd slot RAM)	1990026184N010
Thermal pad (for M.2 B key SATA)	1990036489N010

Suggested M.2 SATA SSD list

Capacity	Type	Temp.	P/N
64G	MLC	-40~85 °C	SQF-SM8M2-64G-SBE
		0~70 °C	SQF-SM8M2-64G-SBC
256G	MLC	0~70 °C	SQF-SM8M4-256G-SBC
	UMLC		SQF-SM8U4-256G-SBC
	3D TLC		SQF-SM8V4-256G-SBC

Embedded Image

- **20703WX9HS0023** WIN10 LTSC x64 V6.05 B045 for i7 version
- **20703WX9VS0027** WIN10 LTSC x64 V6.05 B045 for i3/i5 version

Optional Accessories

- **1702002600** Power cable, 3-pin, 1.8 M, US plug
- **1700018705** Power cable, 3-pin, 1.8 M, EU plug
- **1702031801** Power cable, 3-pin, 1.8 M, UK plug
- **1700000237** Power cable, 3-pin, 1.8M, PSE, Japan
- **UNO-200-DMKAE** DIN-rail kit
- **1700031518-01** DB9 CANbus cable (connect to CN35)
- **UNO-2000G-VMKAE** UNO & FPM integration VESA Mount kit

Please note: If some optional modules are offered with the system, additional system certificates may be required in certain regions/countries. Please contact Advantech for certificate compliance.